

BALL VALVE SPLIT BODY TYPE

Cast iron full bore brass ball NP 16

Art. 037.8600

Execution: cast iron body GG 25 - brass ball OT 58 - ring UNI 7230 - PTFE ball gasket, pivot washer and pivot gasket - BUNA 75 O-Ring - AVP pivot - 9SMnPb36 - lever: until ND 125 UNI 7070 PVC covered, ND 150 and ND 200 lever UNI 7230 - full bore - gauge according to DIN 3203 F4, ND 200 DIN 3202 F5 normatives.

Diameters: ND 25 ÷ ND 200

Max pressure 16 bar

Working temperature -20°C +120°C (buna O-ring)

Working temperature -20°C +160°C (viton O-ring)

Employments: hydrothermal and industrial plants.

On request: particular seals - with stainless steel ball - venturi port - version suited for gas passage - installation of pneumatic actuator simple or double effect (see chapter "L") - electric motorization.

Chart

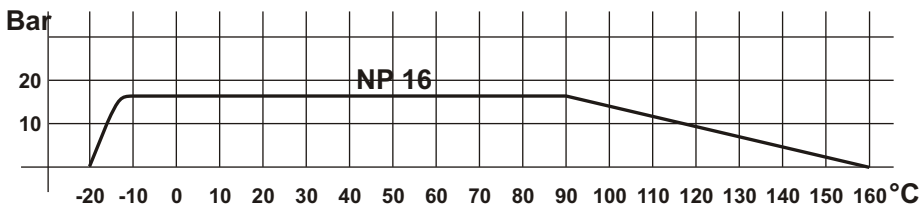

Sizes

ND	D	Y	Z	L	R	P	A	E	F	KV	NP
25	115	85	4xM12	125	174.5	78	58.5	12	8	43	16
32	140	100	4xM16	130	174.5	85	64	12	8	89	16
40	150	110	4xM16	140	250.5	101.5	77	16	10	230	16
50	165	125	4xM16	150	250.5	107.5	84	16	10	265	16
65	185	145	4xM16	170	321.5	125.5	103	20	14	540	16
80	200	160	8xM16	180	321.5	137.5	114	20	14	873	16
100	220	180	8xM16	190	381.5	158	137	24	18	1390	16
125	250	210	8xM16	200	381.5	179.5	159.5	24	18	1707	16
150	285	240	8xM20	210	700	237	201.5	42	30	2024	16
200	340	295	12E22	400	700	279	244	42	30	2720	16

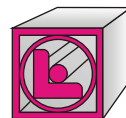

G.OGRINC
katalog strojne
instalacije

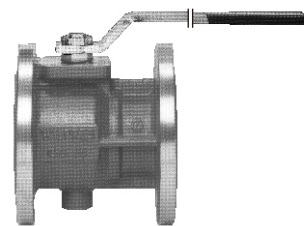

Art. 037.8600

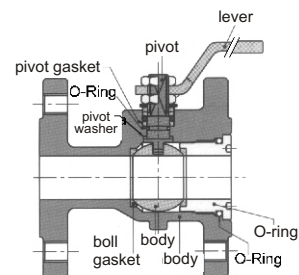

Sec.Art. 037.8600
ND 25 ÷ ND 125

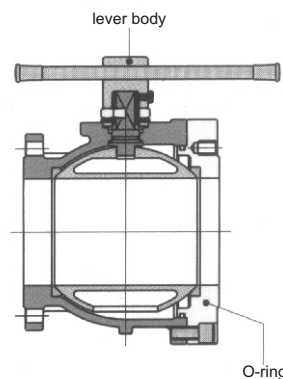

Sec.Art. 037.8600
ND 150 e ND 200

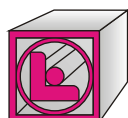
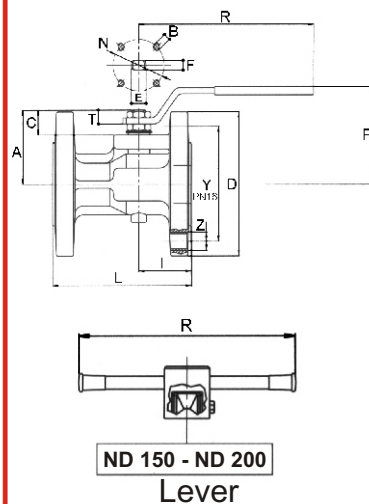

G.OGRINC d.o.o.

Tel.01 361 50 44, Fax.01 361 16 00, e-pošta.gogrinc@siol.net, spleet.www.g-ogrinc.si

VA PO RU SA